



KSRA1 FACE PLATE WITH ALARM

# Installation Manual

Instructions for :-

KSRA1 Face Plate with Alarm

For safe and correct use please read the installation manuals supplied with the equipment.

## Contents

---

Page



3 - 4	Safety precautions
5 - 6	Instructions for KSRA1 Face Plate with Alarm
	General
	Specification
	Dimensions
	Wiring
	Example Wiring Diagram

## Safety precautions

### Before installation and electric work

Before installing the unit, make sure you read all the "Safety precautions".

Symbols used in the text

-  Warning: Describes precautions that should be observed to prevent danger of injury or death to the user.
-  Caution: Describes precautions that should be observed to prevent damage to the unit.

-  Warning: Carefully read the labels affixed to the main unit.

-  Warning:
  - Ask the dealer or an authorised technician to install the unit.  
Improper installation by the user may result in water leakage, electric shock, or fire.
  - Use the specified cables for wiring. Make the connections securely so that any outside forces acting on the cables are not applied to the terminals. Inadequate connection and fastening may generate heat and cause a fire.
  - Never repair the unit. If the controller must be repaired, consult the dealer.  
If the unit is repaired improperly, electric shock, or fire may result.
  - When handling this product, always wear protective equipment. EG: Gloves, full arm protection namely boiler suit, and safety glasses.  
Improper handling may result in injury.
  - If refrigerant gas leaks during installation work, ventilate the room.  
If the refrigerant gas comes into contact with a flame, poisonous gases will be released.
  - Install the controller according to this Installation Manual.  
If the unit is installed improperly, electric shock, or fire may result.  
Have all electric work done by a licensed electrician according to "Electric Facility Engineering Standard", "Interior Wire Regulations" and the instructions given in this manual and always use a special circuit.
  - If the power source capacity is inadequate or electric work is performed im-properly, electric shock and fire may result.  
Keep the electric parts away from any water - washing water etc...  
Contact may result in electric shock, fire or smoke.
  - After completing installation work, make sure that refrigerant gas is not leaking.  
If the refrigerant gas leaks and is exposed to a fan heater, stove, oven, or other heat source, it may generate noxious gases.
  - Do not reconstruct or change the settings of the protection devices.  
If the pressure switch, thermal switch, or other protection device is shorted or operated forcibly, or parts other than those specified by Mitsubishi Electric are used, fire or explosion may result.



To dispose of this product, consult your dealer. Do not use a leak detection additive.

### Precautions for devices that use R410A refrigerant

-  Caution:
  - Do not use the existing refrigerant piping.  
The old refrigerant and refrigerator oil in the existing piping contains a large amount of chlorine which may cause the refrigerator oil of the new unit to deteriorate. Use refrigerant piping made of C1220 (CU-DHP) phosphorus deoxidized copper as specified in the JIS H3300" Copper and copper alloy seamless pipes and tubes". In addition, be sure that the inner and outer surfaces of the pipes are clean and free of hazardous sulphur, oxides, dust/dirt, shaving particles, oils, moisture, or any other contaminant.  
Contaminants on the inside of the refrigerant piping may cause the refrigerant residual oil to deteriorate.
  - Store the piping to be used during installation indoors and keep both ends of the piping sealed until just before brazing.  
(Store elbows and other joints in a plastic bag.) If dust, dirt, or water enters the refrigerant cycle, deterioration of the oil and compressor problems may result.
  - Use ester oil, ether oil or alkylbenzene (small amount) as the refrigerator oil to coat flares and flange connections.  
The refrigerator oil will degrade if it is mixed with a large amount of mineral oil.
  - Use liquid refrigerant to fill the system.  
If gas refrigerant is used to seal the system, the composition of the refrigerant in the cylinder will change and performance may drop.
  - Do not use a refrigerant other than R410A.  
If another refrigerant (R22, etc.) is used, the chlorine in the refrigerant may cause the refrigerator oil to deteriorate.
  - Use a vacuum pump with a reverse flow check valve.  
The vacuum pump oil may flow back into the refrigerant cycle and cause the refrigerator oil to deteriorate.  
Do not use the following tools that are used with conventional refrigerants. (Gauge manifold, charge hose, gas leak detector, reverse flow check valve, refrigerant charge base, vacuum gauge, refrigerant recovery equipment.)
  - If the conventional refrigerant and refrigerator oil are mixed in the R410A, the refrigerant may deteriorate.  
If water is mixed in the R410A, the refrigerator oil may deteriorate.  
Since R410A does not contain any chlorine, gas leak detectors for conventional refrigerants will not react to it.
  - Do not use a charging cylinder. Using a charging cylinder may cause the refrigerant to deteriorate.  
Be especially careful when managing the tools.
  - If dust, dirt, or water gets in the refrigerant cycle, the refrigerant may deteriorate.

## Safety precautions

### Before installation

-  Caution:
- Do not install the unit where combustible gas may leak.  
If the gas leaks and accumulates around the unit, an explosion may result.
-  Caution:
- Ground the unit.  
Do not connect the ground wire to gas or water pipes, lightning rods, or telephone ground lines. Improper grounding may result in electric shock.
  - Install the power cable so that tension is not applied to the cable.  
Tension may cause the cable to break and generate heat which may, in turn, cause fire.
  - Install a leak circuit breaker, as required.  
If a leak circuit breaker is not installed, electric shock may result.
  - Use power line cables of sufficient current carrying capacity and rating.  
Cables that are too small may leak, generate heat, and cause a fire.
  - Use only a circuit breaker and fuse of the specified capacity.  
A fuse or circuit breaker of a larger capacity or a steel or copper wire may result in a general unit failure or fire.
  - Be very careful regarding product transportation.  
Two people should be used to carry products of 20kg or more.
  - Some products use PP bands for packaging. Do not use any PP bands for a means of transportation.
  - Safely dispose of the packing materials.  
Packing materials, such as nails and other metal or wooden parts, may cause stabs or other injuries.  
Tear apart and throw away plastic packaging bags so that children will not play with them - If children play with a plastic bag which has not been torn apart, they face the risk of suffocation.

### Before starting the test run

-  Caution:
- Do not touch the switches with wet fingers.  
Touching a switch with wet fingers can cause electric shock.
  - Do not touch the refrigerant pipes during and immediately after operation.  
During and immediately after operation, the refrigerant pipes may be hot or cold, depending on the condition of the refrigerant flowing through the refrigerant piping, compressor, and other refrigerant cycle parts. Your hands may suffer burns or frostbite if you touch the refrigerant pipes.
  - Do not operate the air conditioner with the panels and guards removed.  
Rotating, hot, or high-voltage parts can cause injuries.
  - Do not turn off the power immediately after stopping operation.  
Always wait at least five minutes before turning off the power. Otherwise, water leakage and other problems may occur.

### Disclaimer

**Warranty:**

All products manufactured on behalf of Mitsubishi Electric UK are warranted against defective materials for a period of three years from the date of delivery to the original purchaser.

 **Warning:**

Mitsubishi Electric UK assumes no liability for damages consequent to the user of this product. We reserve the right to change this manual at any time without notice. The information furnished by us is believed to be accurate and reliable. However, no responsibility is assumed by us for its use, nor for any infringements of patents or other rights of third parties resulting from its use.

## Installation Instructions

### General

KSRA1 face plate with built in alarm buzzer and light. For use in conjunction with KS8-IR8/16C/32C Aspirated Panel.

This product accepts a 12VDC input signal and can provide an output for pump down activation.

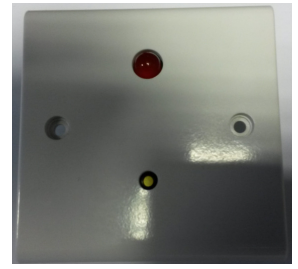

### Specification

Flush Mounting

Fits square single gang BS box 30mm internal depth required

Protrudes 1.5 mm from wall

Buzzer 68dB at 1m

Enclosure Colour : White Plastic

86 x 86 x 31.5 mm

Type	Description	Supply	Operation	Consumption	Mounting
KSRA1	1 Channel	12VDC	Light & Buzzer	70mA	Flush

### Dimensions

KSRA1 Face Plate with Light and Buzzer Alarm.

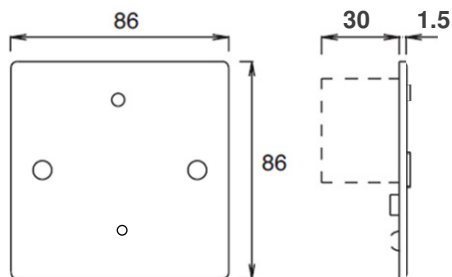

### Wiring

Alarm condition is indicated by LED and buzzer switching on.

The LED and buzzer only switches off when the input returns to normal.

Terminals 0.5 - 1.5mm min signal cable size 7/0.2mm Max length 100m.

Screened cable is recommended. The screen should be earthed at controller end only.

Keep control signal wires away from power cables / units which may cause interference.

# Installation Instructions

## Face Panel KSRA1 Wiring Diagram

KSRA1 Face Plate with alarm indicator and buzzer 12VDC

(For use with KS8-IR8/16C aspirated leak detection panels.)

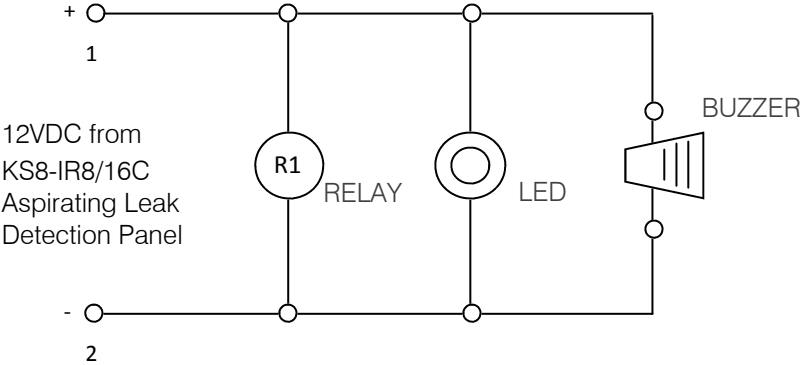

Signal from KS8-IR8/16C Aspirating Detector Zone Alarm Relay

Connect pins 1 & 5 of 5 wire adaptor PAC-SA88HA not supplied  
Max extendable length 10M  
Connect to CN52 of indoor unit

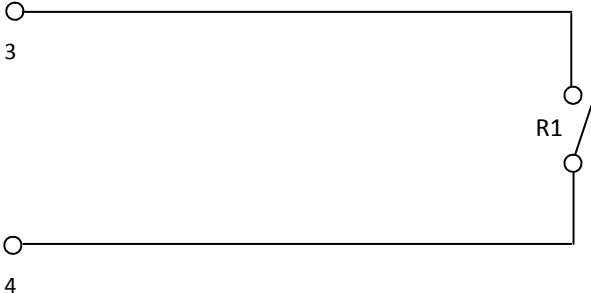

5 wire adaptor to be only used in conjunction with VRF pump down system





---

Please be sure to put the contact address/telephone number  
on this manual before handing it to the customer.



**mitsubishi electric uk**

MITSUBISHI ELECTRIC UK, TRAVELLERS LANE, HATFIELD, HERTFORDSHIRE, AL10 8XB